

# LANDSCAPE LIGHTS

**LEDOS**  
LIGHTING SOLUTIONS

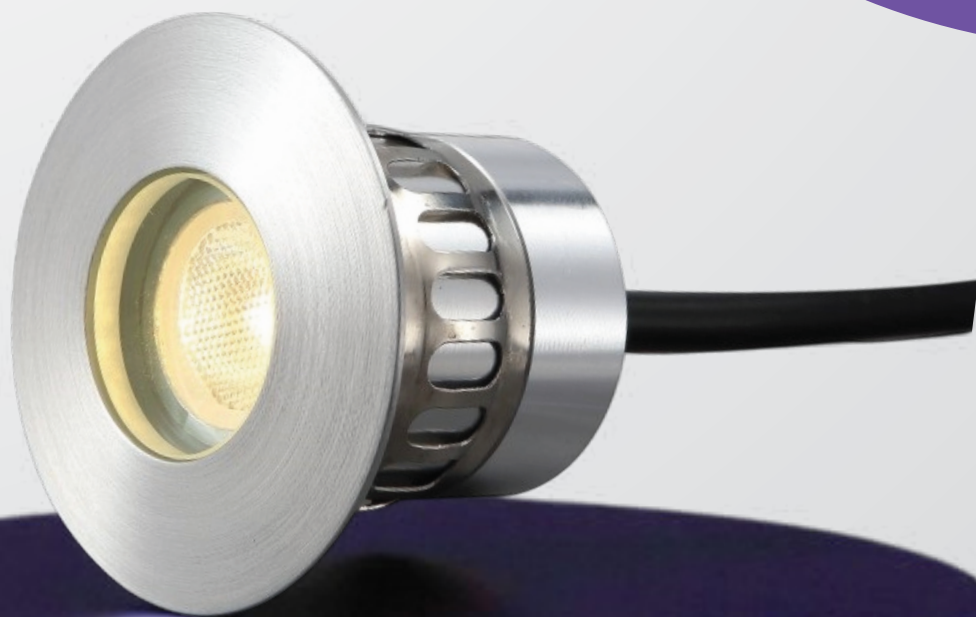

# 01

## **BOLLARD-A**

LD-LFL006211

Introducing the Bollard-A, an elegant addition to outdoor spaces that seamlessly blends artistry with functionality. With its ethereal and sinuous presence, this floor-mounted LED luminaire exudes sculptural beauty while providing warm and expressive illumination. Designed to withstand outdoor elements with its waterproof construction, the Bollard-A transforms gardens into enchanting spaces with its ambient light. Its diffused illumination radiates gently in all directions, creating a genuine and deep atmosphere. Available in three sizes to accommodate various design needs, this luminaire offers versatility and flexibility in outdoor lighting applications. Whether illuminating pathways, garden borders, or outdoor seating areas, the Bollard-A adds a touch of sophistication and charm to any outdoor setting.



### Beam Angle

360° Diffused

### Applications

- Building Facades
- Accent Lighting
- City Squares & Business Plaza
- Shopping Mall
- Pathways

### System Efficacy (lm/W)

Upto 85lm/W

### CRI

>80

### CCT

2700K, 3000K,4000K, 6000K



Sizes	450 - 650 - 800 mm	210 - 410 - 610 mm
Wattage	6W	9W
Lumen	500	800

### Product Dimensions

450mm - 6W - Ø 450 x 60mm

650mm - 6W - Ø 650 x 60mm

800mm - 6W - Ø 800 x 60mm

210mm - 9W - Ø 210 x 102mm

410mm - 9W - Ø 410 x 102mm

610mm - 9W - Ø 610 x 102mm

### Product Impression

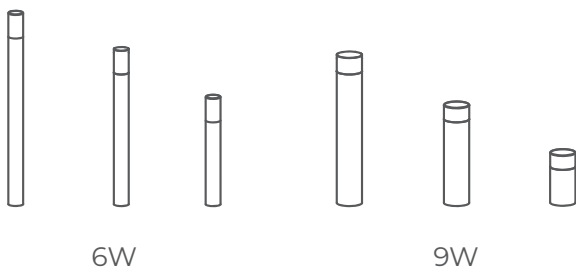

### SDCM

<5

### Dimmable

No

### Material

Aluminium + PMMA

### Lamp Lumen Lifetime

30,000hrs @ L70/B50



# 02

## **CLEFT-RD IP65**

LD-LWA408211

Introducing the Cleft RD IP65 LED outdoor light, designed to elevate accent lighting for walls and façades with unparalleled efficiency and effectiveness. These wall luminaires feature a sleek design with a small overhang and innovative see-through technology. Crafted with precision, the luminaires boast precise cuttings that create defined beams and striking light graphics on the installation surface. The Aluminum fixture with strategically placed clefts ensures minimal wear and tear, enhancing the durability and longevity of the luminaires.

Whether in a round or square design, these luminaires open up new possibilities for accentuating walls and façades, adding a touch of sophistication and visual appeal to any outdoor setting.



## Beam Angle



60°  
Medium

## Applications

- Building Facades
- Accent Lighting
- City Squares & Business Plaza
- Shopping Mall

## System Efficacy (lm/W)

Upto 100lm/W

## CRI

>80

## CCT

2700K, 3000K, 4000K, 6000K

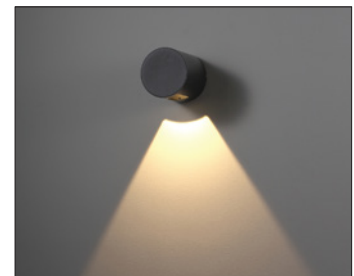
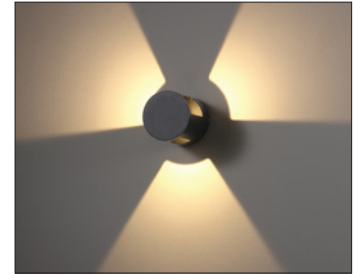
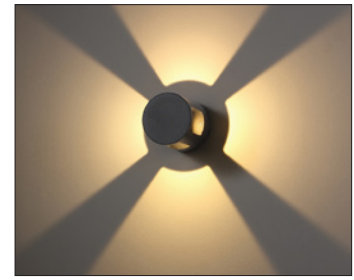

Sizes	Wattage	Lumen
160mm	Single Beam = 3W x 1 Double Beam = 3W x 2 Three Beam = 3W x 3 Four Beam = 3W x 4	Single Beam = 300 lm Double Beam = 600 lm Three Beam = 900 lm Four Beam = 1200 lm

## Product Dimensions

Single Beam - 3W x1 - Ø 160 x 150mm

Double Beam - 3W x2 - Ø 160 x 150mm

Three Beam - 3W x3 - Ø 160 x 150mm

Four Beam - 3W x4 - Ø 160 x 150mm

## Product Impression

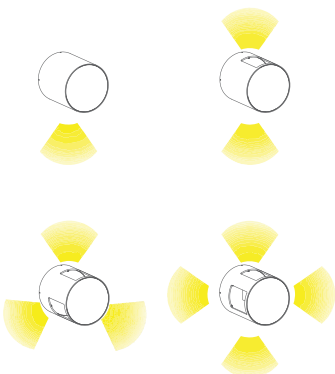

## SDCM

<5

## Dimmable

No

## Material

Aluminium

## Lamp Lumen Lifetime

30,000hrs @ L70/B50

IP65



# 03

## FLOORDOT IP67

LD-ODL001

Introducing the FloorDot IP67 LED outdoor light, a versatile luminaire designed for signage functions with a sleek and functional floor-recessed mounting. Its discreet yet elegant design combines with advanced LED technology to provide efficient upward light emission, making it ideal for accentuating outdoor spaces and pedestrian areas.

Crafted to withstand weight loads, this luminaire offers watertight protection and exceptional durability, ensuring reliable performance in various environments. Its compact dimensions allow for easy installation in both paved and unpaved surfaces, offering flexibility in placement and application. With low energy consumption and impressive material quality, the FloorDot IP67 is a sustainable lighting solution that combines style with functionality.



### Beam Angle

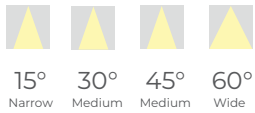

### Applications

- Building Facades
- Accent Lighting
- City Squares & Business Plaza
- Shopping Mall
- Pathways
- Bridges, Trees, Shrubs

### System Efficacy (lm/W)

Upto 50lm/W

### CRI

>80

### CCT

2700K, 3000K,4000K, 6000K (Red, Green, Blue)

Sizes	38 mm	48 mm	55 mm
Wattage	1W	3W	3W
Lumen	70 lm	120 lm	120 lm

### Product Dimensions

1W - 38mm - Ø 38 x 47mm

3W - 48mm - Ø 48 x 50mm

3W - 55mm - Ø 55 x 50mm

### Product Impression

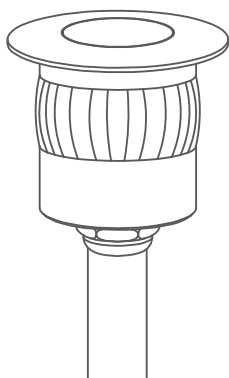

### SDCM

<5

### Dimmable

No

### Material

SS Body - Aluminium Floor Case

### Lamp Lumen Lifetime

30,000hrs @ L70/B50



# 04

## **MUSHROOM BOLLARD**

LD-LFL04829

Introducing the Mushroom Bollard, an elegant addition to outdoor spaces that seamlessly blends artistry with functionality. With its ethereal and sinuous presence, this floor-mounted LED luminaire exudes sculptural beauty while providing warm and expressive illumination. Designed to withstand outdoor elements with its waterproof construction, the Mushroom Bollard transforms gardens into enchanting spaces with its ambient light.

Its diffused illumination radiates gently in all directions, creating a genuine and deep atmosphere. Whether illuminating pathways, garden borders, or outdoor seating areas, the Mushroom Bollard adds a touch of sophistication and charm to any outdoor setting.



### Beam Angle

Indirect Spread

### Applications

- Building Facades
- Accent Lighting
- City Squares & Business Plaza
- Shopping Mall
- Pathways

### System Efficacy (lm/W)

Upto 100lm/W

### CRI

>80

### CCT

2700K, 3000K,4000K, 6000K

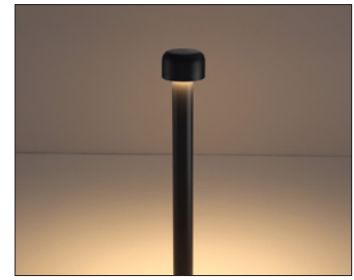

Sizes	380 mm - 800 mm
Wattage	6W
Lumen	600 lm

### Product Dimensions

380mm - 6W - Ø 380 x 125mm

800mm - 6W - Ø 800 x 125mm

### Product Impression

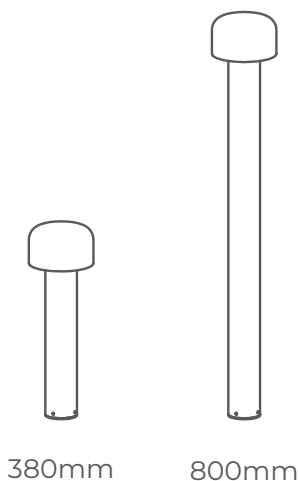

### SDCM

<5

### Dimmable

No

### Material

Aluminium + PMMA

### Lamp Lumen Lifetime

30,000hrs @ L70/B50

IP65



# 05

## **PATH BOLLARD**

LD-LFL059262

Introducing the FloorDot IP67 LED outdoor light, a versatile luminaire designed for signage functions with a sleek and functional floor-recessed mounting. Its discreet yet elegant design combines with advanced LED technology to provide efficient upward light emission, making it ideal for accentuating outdoor spaces and pedestrian areas.

Crafted to withstand weight loads, this luminaire offers watertight protection and exceptional durability, ensuring reliable performance in various environments. Its compact dimensions allow for easy installation in both paved and unpaved surfaces, offering flexibility in placement and application. With low energy consumption and impressive material quality, the FloorDot IP67 is a sustainable lighting solution that combines style with functionality.



### Beam Angle



38°  
Medium

### Applications

- Building Facades
- Accent Lighting
- City Squares & Business Plaza
- Shopping Mall
- Pathways

### System Efficacy (lm/W)

Upto 85lm/W

### CRI

>80

### CCT

2700K, 3000K, 4000K, 6000K



Sizes	350mm - 600mm
Wattage	6W x 1 - 6W x 2
Lumen	500 lm - 1000 km

### Product Dimensions

350mm - 6W x1 - Ø 350 x 130mm

350mm - 6W x2 - Ø 600 x 130mm

600mm - 6W x1 - Ø 350 x 200mm

600mm - 6W x2 - Ø 600 x 200mm

### Product Impression

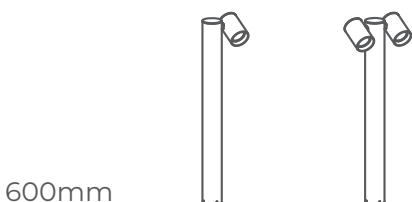

### SDCM

<5

### Dimmable

No

### Material

Aluminium

### Lamp Lumen Lifetime

30,000hrs @ L70/B50



# 06

## **SLIT-SQ IP65**

LD-LWa300

Introducing the Slit SQ IP65 LED outdoor light, designed to deliver effective and efficient accent lighting for walls and façades. This wall luminaire boasts a sleek design with a small overhang and innovative see-through technology. Crafted with precision, the luminaire features precise slit cuttings that create defined beams and striking light graphics on the installation surface. The Aluminum fixture with slits ensures minimal wear and tear, enhancing the durability and longevity of the luminaire.

Whether in a round or square design, this luminaire opens up new possibilities for accentuating walls and façades, adding a touch of sophistication and visual appeal to any outdoor setting. Illuminate your outdoor spaces with precision and style using the Slit SQ IP65, the ultimate choice for accent lighting that makes a statement.

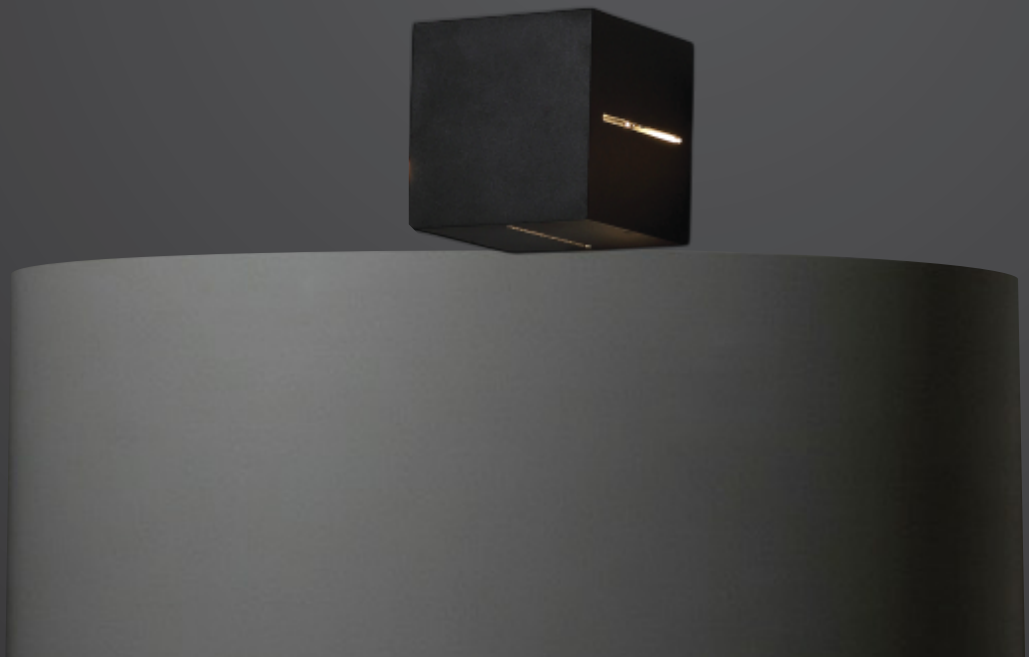

## Beam Angle



8°  
Narrow

## Applications

- Building Facades
- Accent Lighting
- City Squares & Business Plaza
- Shopping Mall

## System Efficacy (lm/W)

Upto 100lm/W

## CRI

>80

## CCT

2700K, 3000K, 4000K, 6000K

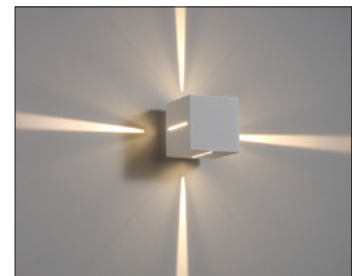
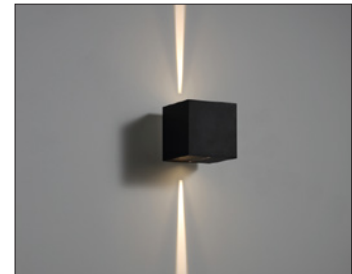

Sizes	Wattage	Lumen
130mm x 130mm	Single Beam = 3W x 1 Double Beam = 3W x 2 Four Beam = 3W x 4	Single Beam = 300 lm Double Beam = 600 lm Four Beam = 1200 lm

## Product Dimensions

Single Beam - 3W x1 - Ø 130 x 130 x 166mm

Double Beam - 3W x2 - Ø 130 x 130 x 166mm

Four Beam - 3W x4 - Ø 130 x 130 x 166mm

## Product Impression

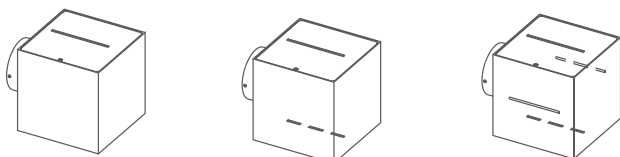

## SDCM

<5

## Dimmable

No

## Material

Aluminium

## Lamp Lumen Lifetime

30,000hrs @ L70/B50

IP65



# 07

## **SPIKESPOT IP65**

LD-ODL03426

Introducing the SpikeSpot IP65, a sophisticated LED outdoor luminaire designed to enhance the natural beauty of your landscape with precision lighting. Mounted securely into the ground with a stake, this discreet fixture seamlessly integrates into garden beds, pathways, or outdoor spaces, offering adjustable light emission tailored specifically for illuminating plants and architectural elements.

Its sleek and unobtrusive design ensures that the spotlight itself remains inconspicuous, allowing the illuminated object to take center stage. With its easy-to-move light, you can effortlessly highlight your favorite plants, trees, or garden features, adding depth and dimension to your outdoor space.



### Beam Angle

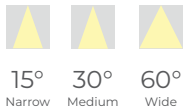

### Applications

- Accent Lighting
- City Squares & Business Plaza
- Shopping Mall
- Bridges, Trees, Shrubs

### System Efficacy (lm/W)

Upto 70lm/W

### CRI

>80

### CCT

2700K, 3000K, 4000K, 6000K (Red, Green, Blue)



Sizes	43mm	52mm	77mm
Wattage	3W	6W	9W
Lumen	120 lm	420 lm	630 lm

### Product Dimensions

3W - Ø 43 x 78mm

6W - Ø 52 x 78mm

9W - Ø 77 x 68mm

### Product Impression

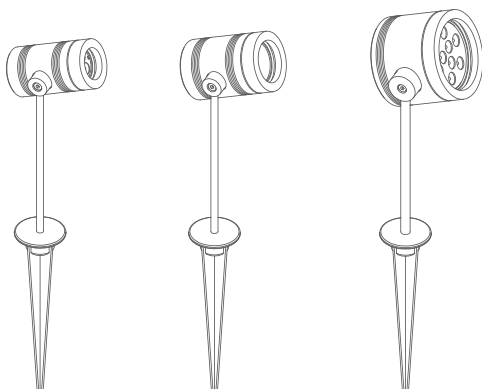

### SDCM

<5

### Dimmable

No

### Material

Aluminium

### Lamp Lumen Lifetime

30,000hrs @ L70/B50



# 08

## UFO IN-GROUND

IP67 LD-ODL03123

Introducing the UFO In-Ground IP67 LED outdoor light, a sophisticated luminaire designed to accentuate architectural elements and outdoor landscapes with its upward light emission technology. This floor-recessed LED luminaire is specifically engineered to illuminate structures, walls, trees, gardens, and other features from below, enhancing their visual presence and creating captivating lighting effects. Installed within a housing on a foundation provided by the customer, the luminaire is capable of withstanding pressure loads and can even be driven over by vehicles with pneumatic tires, ensuring durability and longevity in various outdoor environments. With its innovative design and versatile functionality, the UFO In-Ground IP67 LED light offers a seamless blend of form and function, allowing for the creation of striking lighting compositions that elevate outdoor spaces.



### Beam Angle

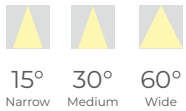

### Applications

- Accent Lighting
- City Squares & Business Plaza
- Shopping Mall
- Bridges, Trees, Shrubs

### System Efficacy (lm/W)

Upto 70lm/W

### CRI

>80

### CCT

2700K, 3000K, 4000K, 6000K (Red, Green, Blue)



Sizes	55mm	65mm	90mm
Wattage	3W	6W	9W
Lumen	210 lm	420 lm	630 lm

### Product Dimensions

3W - Ø 55 x 56mm

6W - Ø 65 x 76mm

9W - Ø 90 x 66mm

### Product Impression

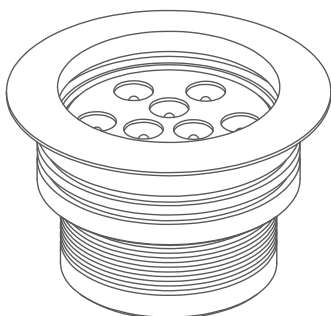

### SDCM

<5

### Dimmable

No

### Material

SS Body - Aluminium Floor Case

### Lamp Lumen Lifetime

30,000hrs @ L70/B50





# LEDOS

LIGHTING SOLUTIONS

*Redefining Lighting*



+92 42 35847561 | +92 42 35847562



Office#410, 4th Floor, Al-Qader Heights,  
New Garden Town Lahore, Pakistan



[info@ledoslighting.com](mailto:info@ledoslighting.com)